

Inverter Driven Heat Pump

36,000 BTU Multi Position AHU

Job Name _____
 Location _____
 Engineer _____
 Submitted To _____
 Submitted By _____
 Reference _____

Date _____
 Approval _____
 Construction _____
 Unit No _____
 Drawing No _____

PRODUCT FEATURES

- Up to 1.0" WC
- 2-Wire Wired Remote Controls
- Aluminum Indoor Unit Coil
- True four position : Up,Down,Right/Left
- Long Lineset Lengths (up to 246')
- Low Air Leakage Rate (2% or less)
- Built in Base Pan Heater
- Heating operation rated down to -15°F outdoor temperature
- Integral Electric Heat Kit - Optional
- Airzone Zoning Kit - Optional



MODEL NUMBERS			
Indoor Unit	AMUG36LMAS		
Outdoor Unit	AOUH36LMAH1		
System	36LMAH1M		
EFFICIENCIES			
SEER	17.3		
SEER 2	17.1		
EER	11.5		
EER 2	11		
HSPF	11		
HSPF 2	10.4		
COP	kW/kW	3.9	
COP	Btu/hW	13.3	
COP2	kW/kW	3.76	
COP2	Btu/hW	12.8	
OUTDOOR TEMPERATURE OPERATION RANGE			
Cooling	*F(°C)	-5 to 115 (-21 to 46)	
Heating		-15 to 75 (-26 to 24)	
CAPACITIES			
Cooling	Rated	Btu/h	33000
	Min.-Max.		13,000-39,000
Heating	Rated		38000
	Min.-Max.		15,000-52,000
LINESET REQUIREMENTS			
Connection Method		Flare	
Liquid	in (mm)	Ø 3/8 (Ø 9.52)	
Gas		Ø 5/8 (Ø 15.88)	
Pre-charge length	ft (m)	98 (30)	
Minimum Length		16 (5)	
Max. length		246 (75)	
Max. height difference		98 (30)	
INDOOR DIMENSIONS & WEIGHT			
Net (H x W x D)	in (mm)	57 x 21 x 21-11/16	
Gross (H x W x D)		57-1/8 x 23 x 26-1/2	
Net Weight	lb (kg)	132 (60.0)	
Gross Weight		146 (66.0)	
OUTDOOR DIMENSIONS & WEIGHT			
Net (H x W x D)	in (mm)	52-1/2 x 38-3/16 x 14-9/16	
Gross (H x W x D)		59-5/16 x 41-7/8 x 18-13/16 (1,506 x 1,064 x 478)	
Net Weight	lb (kg)	236 (107)	
Gross Weight		260 (118)	

Warranty Information



7 Year Compressor, 5 Year Parts out-of-the-box Warranty



10 Year Compressor, 10 Year Parts Warranty when registered within 60 days of installation in a residence



12 Year Compressor, 12 Year Parts Warranty when registered within 60 days of installation in a residence, and installed by a Fujitsu Elite contractor

ACCESSORIES

UTY-RNRUZ-Series	Wired Remote Controller
UTY-RSRY	Simple Remote Controller
UTY-RHRY	Simple Remote Controller
UTY-LBTUM	IR Receiver Kit with Wireless Remote Controller
UTY-XSZX	Remote Sensor Unit
UTY-XWZXZG	External Connect Kit
UTY-XCSX	External Input and Output PCB
UTY-XWZXZJ	Wire Kit
UTY-VTGX	Network Converter
UTY-TTRXZ1	Thermostat Converter
UTY-VMSX	Modbus Converter

Due to continuous product improvements, specifications are subject to change without notice. Please log in to the Fujitsu Portal for the most up-to-date documentation <https://connect.fujitsugeneral.com>

Effective Date: 3/30/2023

Inverter Driven Heat Pump

36,000 BTU Multi Position AHU

FAN DATA				
Indoor Unit Airflow rate	Cooling	HIGH	CFM (m3/h)	1,200 (2,039)
		MED		740 (1,257)
		LOW		590 (1,002)
		QUIET		490 (833)
	Heating	HIGH		1,200 (2,039)
		MED		740 (1,257)
		LOW		590 (1,002)
		QUIET		490 (833)
Outdoor Unit Airflow rate	Cooling		3,767 (6,400)	
	Heating		3,649 (6,200)	
SOUND PRESSURE				
Indoor Unit	Cooling	HIGH	dB (A)	41
		MED		30
		LOW		27
		QUIET		24
	Heating	HIGH		40
		MED		35
		LOW		28
		QUIET		26
Outdoor Unit	Cooling		52	
	Heating		53	
REFRIGERANT				
Type				R410A
Charge	lb oz			10 lb 9 oz
	g			4800
Oil Type				POE (RB68)

ELECTRICAL SPECIFICATIONS					
Voltage/Frequency/Phase		208/230 V ~ 60 Hz			
Available Voltage Range		187–253 V			
Current	Cooling	Rated	A	13.4	
	Heating	Rated		13.2	
Maximum Operating Current	Cooling			23.9	
	Heating			32.9	
Starting current		12.8			
MCA		38.7			
Maximum Circuit Breaker		40			
Input Power	Cooling	Rated		kW	3
		Min.–Max.	0.85–3.66		
	Heating	Rated	2.96		
Min.–Max.		0.90–4.96			
Power Factor	Cooling				97.3
	Heating				97.5
OTHER					
Moisture Removal		pints/h (L/h)	6.6 (3.1)		
Energy Star		No			
Drain hose	Material		LDPE		
	Tip diameter	in (mm)	Ø1/2 (13.0) [I.D.], Ø5/8 to Ø11/16 (16.0 to 16.7) [O.D.]		
Operation Range	Cooling	°F (°C)	64 to 90 (18 to 32)		
	Heating	%RH	–		
Static pressure range		inWG (Pa)	0.08 to 1 (20 to 250)		

DIMENSIONS:

Units: In. (mm)

Indoor Unit:

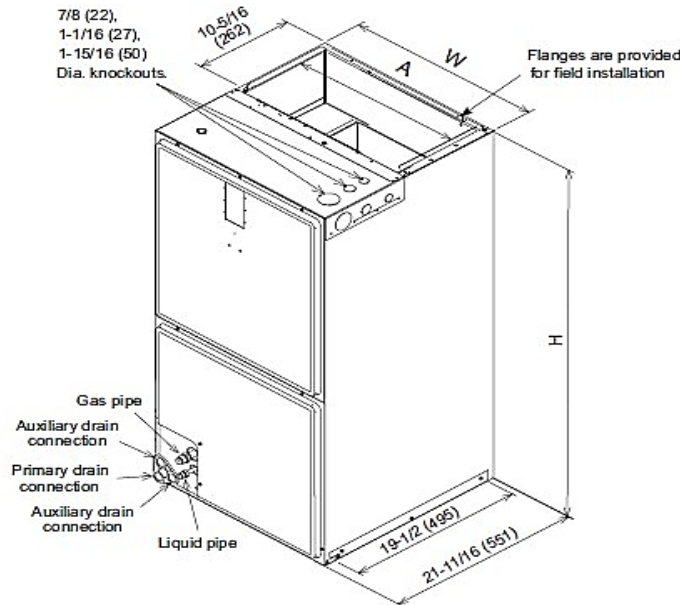

Model	A (Supply duct)	W (Unit width)	H (Unit height)
AMUG36LMAS	19-1/2 (495)	21 (533)	57 (1,448)

Return Opening Dimensions	
Width	Depth
19 3/8	19 3/4

DIMENSIONS

Units: In. (mm)

Outdoor Unit

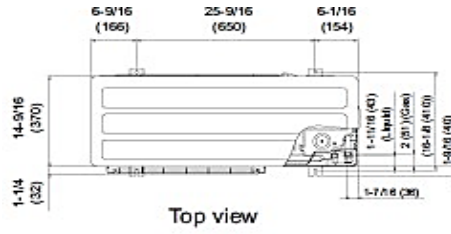

Top view

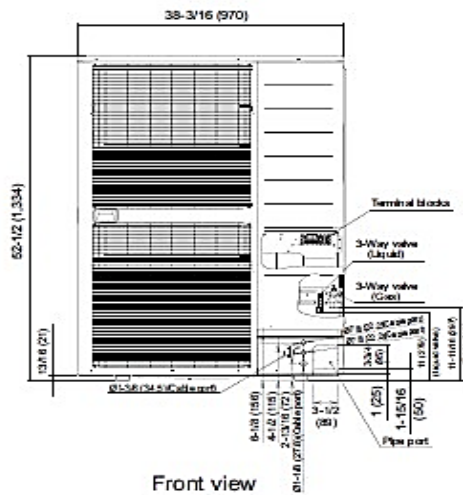

Front view

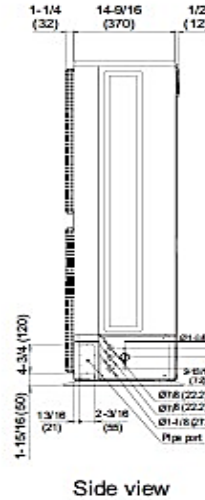

Side view

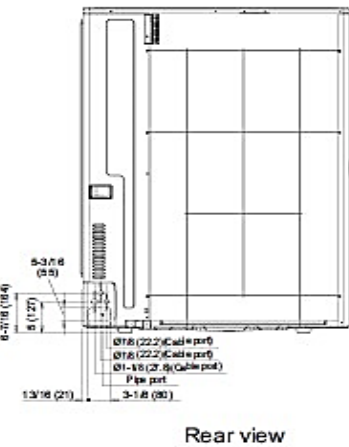

Rear view

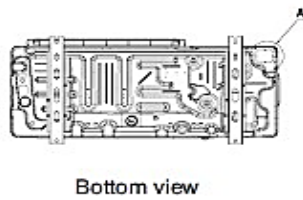

Bottom view

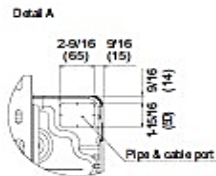

The Fujitsu logo is a worldwide trademark of Fujitsu General Limited. The Airstage logo and name is a worldwide trademark of Fujitsu General Limited and is a registered trademark in Japan, the USA and other countries or areas. Copyright 2022 Fujitsu General America, Inc. Fujitsu's products are subject to continuous improvements. Fujitsu reserves the right to modify product design, specifications and information in this brochure without notice and without incurring any obligations.

Note: Specifications are based on the following conditions:
Cooling: Indoor temperature of 80°F (26.7°C) DB/67°F (19.4°C) WB, and outdoor temperature of 95°F (35°C) DB/75°F (23.9°C) WB. Heating: Indoor temperature of 70°F (21.1°C) DB/60°F (15.6°C) WB, and outdoor temperature of 47°F (8.3°C) DB/43°F (6.1°C) WB. Pipe length: 25ft. (7.5m), Height difference: 0ft. (0m) (Outdoor unit - indoor unit).

Electric Heat Kit

For 3 Ton System:

HEATER PART #	STAGE	VOLTAGE	PH/HZ	HEATER KW	HEATER AMPS	DESCRIPTION
RXBH-1724A03J-A	SINGLE	208/240	1/60	2.25 / 3.0	10.8 / 12.5	3 KW ELECTRIC HEAT KIT WITH BREAKER 208/230 1PH
RXBH-1724A05J-A	SINGLE	208/240	1/60	3.6 / 4.8	17.3 / 20.0	5 KW ELECTRIC HEAT KIT WITH BREAKER 208/230 1PH
RXBH-1724A07J-A	SINGLE	208/240	1/60	5.4 / 7.2	26.0 / 30.0	7 KW ELECTRIC HEAT KIT WITH BREAKER 208/230 1PH
RXBH-1724A10J-A	SINGLE	208/240	1/60	7.2 / 9.6	34.6 / 40.0	10 KW ELECTRIC HEAT KIT WITH BREAKER 208/230 1PH
RXBH-1724B05J-A	SINGLE	208/240	1/60	3.6 / 4.8	17.3 / 20.0	5 KW ELECTRIC HEAT KIT NO BREAKER 208/230 1PH
RXBH-1724B07J-A	SINGLE	208/240	1/60	5.4 / 7.2	26.0 / 30.0	7 KW ELECTRIC HEAT KIT NO BREAKER 208/230 1PH
RXBH-1724B10J-A	SINGLE	208/240	1/60	7.2 / 9.6	34.6 / 40.0	10 KW ELECTRIC HEAT KIT NO BREAKER 208/230 1PH
RXBH-1724C05J-A	SINGLE	208/240	1/60	3.6 / 4.8	17.3 / 20.0	HTR KIT-5KW 208/230/1/60 (PULL OUT DISCONNECT)
RXBH-1724C07J-A	SINGLE	208/240	1/60	5.4 / 7.2	26.0 / 30.0	HTR KIT-7KW 208/230/1/60 (PULL OUT DISCONNECT)
RXBH-1724C10J-A	SINGLE	208/240	1/60	7.2 / 9.6	34.6 / 40.0	HTR KIT-10KW 208/230/1/60 (PULL OUT DISCONNECT)

Accessories:

Model #	Description
RXHB-21	COMBUSTIBLE FLOOR BASE 21"
RXHF-21	EXTERNAL FILTER BASE FOR FAN COILS - 21"
RXBJ-A21	JUMPER BAR (USED WITH 13KW OR LARGER HEATER KIT)